

Technical information

ACRYLITE® LED (EndLighten)

Light guiding edge lit acrylic

Product

ACRYLITE® LED (EndLighten) is the perfect solution for edge-lit applications. Light is fed in via the edge of the highly transparent material and evenly emitted across the surface. ACRYLITE® LED (EndLighten) is a transparent colorless material offered in various grades and thicknesses.



Example of a non-transparent application

Transparent applications

ACRYLITE® LED (EndLighten) is the ideal material for evenly illuminating a transparent surface with LEDs. The surface glows in the same color as the chosen LED.



Transparent

If no light is fed in, the material offers a clear view without any disturbing optical effects due to clouding, halftone printing or inscribed textures. This makes it perfectly suited for architecture and design, furniture, store fixtures or exhibition booths. It can be used for example as an illuminated partition or door infill panel, or for ambient lighting.



Transparent application with and without light

Non-transparent applications

In non-transparent applications, ACRYLITE® LED (EndLighten) is the ideal material for very slim, large-scale luminous displays and picture frames, luminous ceilings and walls, city light posters and many other uses. In the application shown here (counter), light is fed in via the edge of the ACRYLITE® LED (EndLighten) sheet. ACRYLITE® Reflections (Radiant) is used as the patterned sheet.



In this non-transparent application, light is fed in via the edge of the ACRYLITE® LED (EndLighten) sheet and emitted across the surface. ACRYLITE® Satinice is used as the diffuser sheet. The color of the surface is determined by the color of the LEDs.

Mode of operation

Operating principle

The clear light-diffusing particles embedded in the PMMA deflect the light rays entering the sheet edge. Total internal reflection in the light guide is suppressed, allowing light rays to exit the sheet via the surfaces in a controlled manner. This effect provides a uniformly glowing surface.

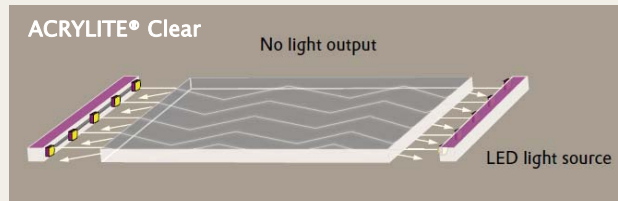

Clear ACRYLITE® conducts light by means of total internal reflection. Light rays remain inside the sheet only exit via the edges.

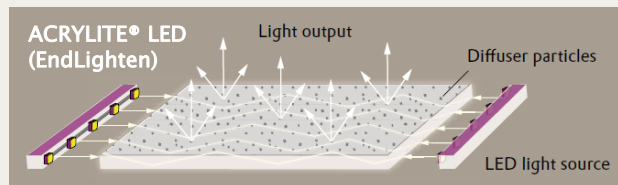

The diffuser particles embedded in ACRYLITE® LED (EndLighten) deflect light rays and suppress total internal reflection. Light rays can exit the sheet via the surfaces too.

Material properties

Area to be illuminated

In order to determine the size of the light guide, it has proved useful to define the area to be illuminated. This is:

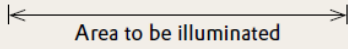

Detailed drawings to define the area to be illuminated

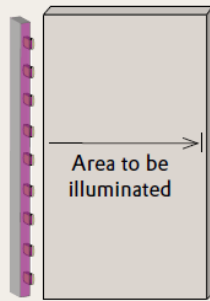

Light input on one side

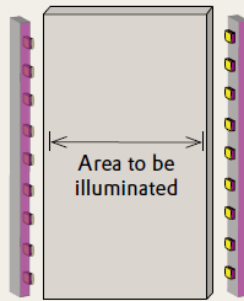

Light input on two sides

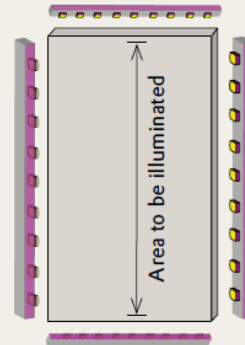

Light input on four sides

Panel Size

LED double sided	LED single sided	Recommended Grade
 Up to 12 inches	 Up to 6 inches*	0E010 SM
 12 to 24 inches	 6 to 12 inches*	0E011 L
 24 to 48 inches	 12 to 24 inches*	0E012 XL
 48 to 78 inches	 24 to 39 inches*	0E013 XXL

* Reflective edge tape opposite LEDs recommended

Luminance

Depending on the size of the light guide, various grades of ACRYLITE® LED (EndLighten) are offered. The diagram on the right shows the average luminance values*.

Grades SM and L provide higher luminance than grades XL or XXL, since the same amount of light that is fed in at the edge is distributed across a smaller surface.

In order to achieve optimal and uniform luminous efficiency, it is very important to use the recommended grade of ACRYLITE®LED (EndLighten) (SM to XXL).

Efficiency and uniformity

Efficiency describes how much input light is emitted across the surface.

Uniformity refers to even illumination of the sheet, i.e. the relationship between minimal and maximal luminance.

The diagrams show the values measured at the recommended maximum lengths of the respective grades. Measurements show that uniformity and efficiency move in opposite directions, and the grades were optimized correspondingly. Since the human eye perceives brightness logarithmically, it cannot recognize differences less than about 30%.

Efficiency *

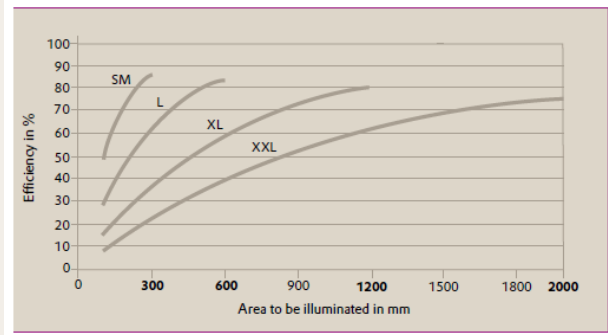

Uniformity L_min/L_max *

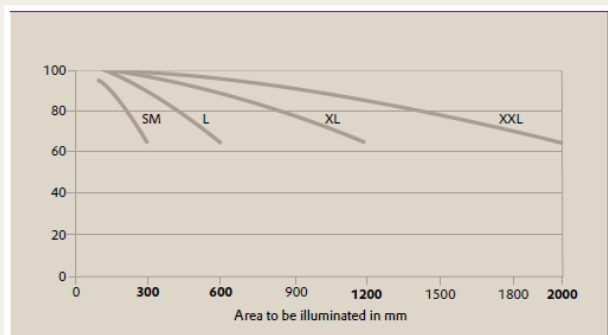

Average luminance of ACRYLITE® LED (EndLighten) grades *

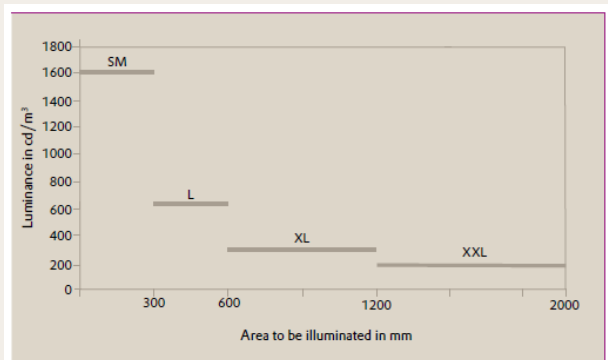

* the graphs in the diagrams above are based on values measured with a one-sided light input of about 1,734 lm/m.

* with lighting on both sides (light input on one side: 1,734 lm/m), using a reflector and a white poster

Forming ACRYLITE® LED (EndLighten)

ACRYLITE® LED (EndLighten) can be thermoformed, e.g. curved (see figure below). The lighting properties remain more or less intact. It should be ensured that the radius of curvature r does not fall below the critical value for the given material thickness d . Light rays that are fed into the edge closer to the center of the curvature impinge on the surface at an angle that is smaller than the critical angle of total internal reflection, due to the curved surface.

This means the light is not conducted into the sheet at this point, but involuntarily passes across the surface to the outside. At this point, the surface shines brightly, whereas this light is missing further from the point of light input and can no longer reach the surface via the diffuser particles. This may result in an unevenly lit surface.

The following formula therefore has to be borne in mind:

Critical math value: $r \geq 3.2 \cdot d$

In practice we recommend a radius of curvature of: $r \geq 6x$ material thickness

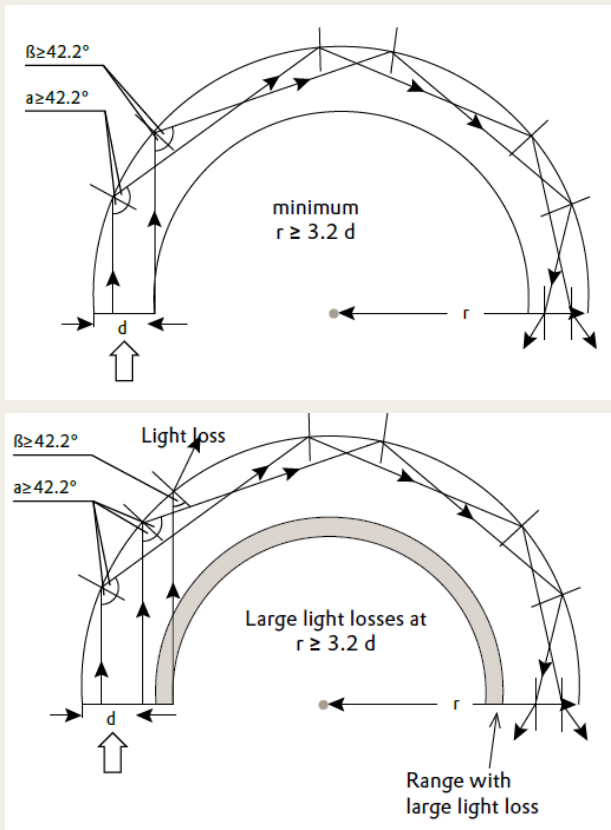

Free forming

Both rectangular and round displays can be fabricated. Consideration should be given, however, to the mechanism used by the light guide to conduct and distribute the light so that it is uniformly emitted towards the front. This is easy to establish with ACRYLITE® LED (EndLighten) because the material does not use any patterns in order to achieve the diffusion effect, and the direction of light input is therefore irrelevant.

The diffuser sheet only has to be cut in the same shape as the front display (see page 7 for recommended materials).

In these cases, it is best to use LED modules as the light source. These are mounted on flexible strips to follow the contour of the sheet. This makes it possible to simply feed the light into the edge of the diffuser sheet.

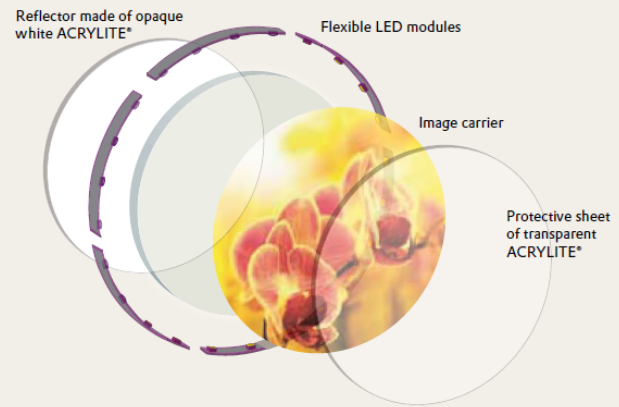

Indications for optimal use of ACRYLITE® LED (EndLighten)

Transparent applications

Greater brightness in transparent applications

ACRYLITE® LED (EndLighten) contains specially optimized diffuser particles that deflect light rays much more effectively than other diffuser particles. This causes light rays to exit the sheet surface of the light guide at a much more vertical angle. The frontal brightness is therefore 250%* higher than

with conventional ACRYLITE® EndLighten, so the sheet appears two and a half times as bright.

Comparison of luminance (grade L; lighting on both

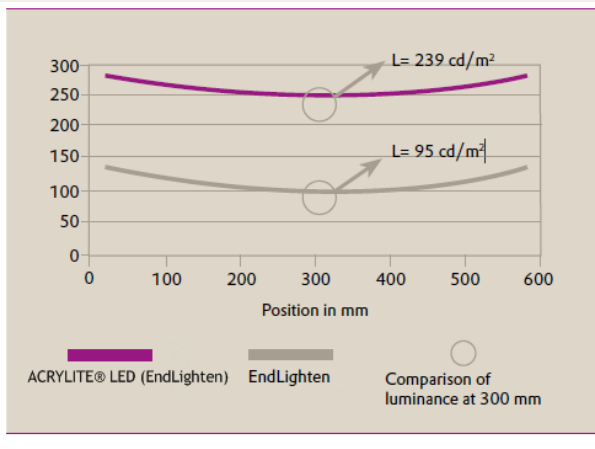

* This comparison applies to transparent applications, i.e. using ACRYLITE® LED (EndLighten) without a reflector and/or diffuser.

Light emission and structure

For transparent applications, all the edges of the illuminated sheet can be clamped in an aluminum frame, for example. The sheet must be covered especially at the points where light is fed in so that the LED strips cannot be seen.

There is no need to use a reflector or diffuser in transparent applications. The light therefore exits both sheet surfaces.

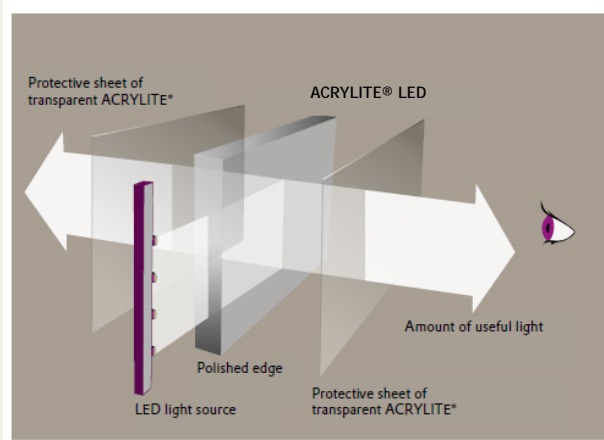

Optimized structure of a transparent application

The light-guiding function ACRYLITE® LED (EndLighten) may be disturbed by soiling on the sheet, e.g. finger marks, but also by surface scratches.

Light is refracted at these points and is therefore emitted more strongly. To prevent this, an abrasion resistant coating can be added to one or both sides of the sheet. Since this protective coating does not influence the light-guiding function of ACRYLITE® LED (EndLighten), soiling or scratches do not show through!

Non-transparent applications

Light emission on one or both sides

Luminous signs can be built with one or two light-emitting sides. If the sign is to emit light on one side only, the backing panel should be as light-proof and light-reflecting as possible. Both mirror and diffusely reflecting materials can be used. If both sides are to emit light, both covers and image carriers should be made of the same material, if possible. The use of diffusers directs the light more strongly towards the viewer and thus increases the impression of brightness.

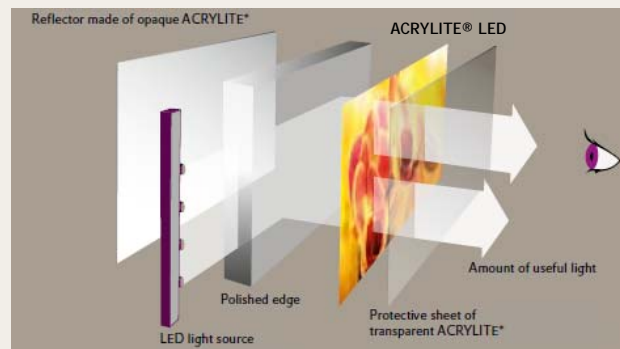

Structure

The figure above shows the optimized structure of an illuminated advertising sign that emits light on one side. This type of structure maximizes the amount of useful light, i.e. the light that is not lost by premature emission at the edges or the surface, in non-transparent applications.

Application of the image carrier

The covers or image carriers must not be bonded or laminated onto the entire surface of the ACRYLITE® LED (EndLighten), because optical contact would produce disturbing brightening or darkening effects. The correct spacing should therefore be observed during construction.

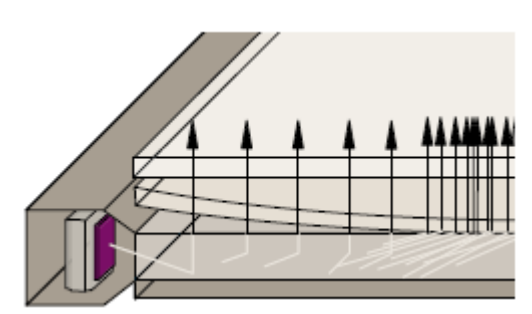

Optical contact:

Sheet/poster: optical disturbances

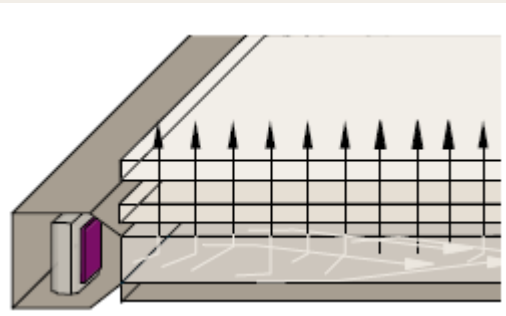

No optical contact:

Sheet/poster: light is only emitted through the ACRYLITE® LED (EndLighten) sheet.

Even a drop of water (see picture below) can impair light emission and lead to irregular brightening. The light output is always balanced, i.e. to achieve uniform distribution, light is lost in other places. That means a poster may be placed on the sheet, but should not be bonded to it!

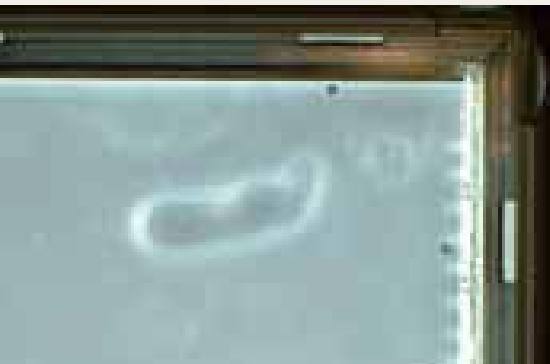

Recommended Materials to work with ACRYLITE® LED (EndLighten)

LED Strips

- International Light Technologies
“ILT-FLX350-OS50” or “ILT-FLX350-OS40”
(978) 818-6180
<http://www.intl-lighttech.com/products/light-source/signage/edge-acrylics/>
- Principal LED- “The Spec Edge”
(325) 227-4577
<http://www.p-led.com>

White Reflective Backer (for non transparent applications)

- Polystyrene *
- ACRYLITE® FF WT020 *
- White Optics F23

Edge Reflective tape

- www.findtape.com- JVCC MPF-01 Metalized Polyester Film Tape (Reflective) Color: Silver

Aluminum Frames

- U Channels
- Signcomp- <http://www.signcomp.com>
- Signalex- <http://www.signalex.com>

* Distributed by most ACRYLITE® Distributors

Indications on edge lighting with LEDs

Unlike fluorescent tubes, LEDs are spot-shaped light sources. This means that the points at which light is fed in are brighter, though this brightness fades again after a few millimeters. The frame system should therefore cover this area.



A practical rule for using LEDs

The cover should be as wide as the spacing between the LEDs.

As a rule, LEDs emit light at an angle of 120–140°.

Example:

If the space between the LEDs is 25 mm, the frame should be about 25 mm wide to cover the light source.

The LEDs should be installed as close to the edge as possible to ensure optimal light input.

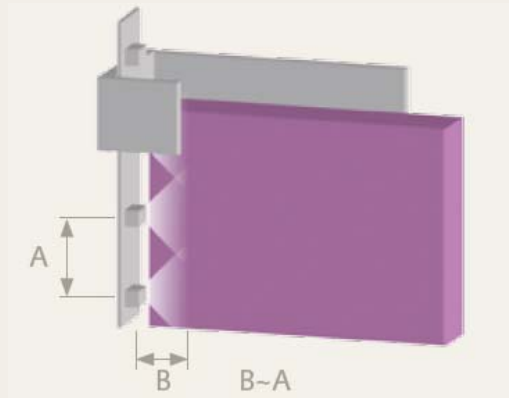

Typical structure of an ACRYLITE® LED (EndLighten) frame system

Polishing the material edges:

All edges should be polished. To minimize diffusion losses during light input, rough edges are smoothed by means of diamond milling cutters or flame polishing. Laser-cut edges require no further polishing.

Treating surface scratches

Scratches can be completely removed from ACRYLITE® LED (EndLighten) by polishing.

If the surface is damaged due to external influences, more light is emitted and uniform light distribution is impaired (see lighter spots in the picture on the right).

Polishing makes it possible to completely restore the optical properties of ACRYLITE® LED

(EndLighten). Light is once again uniformly distributed in the sheet.

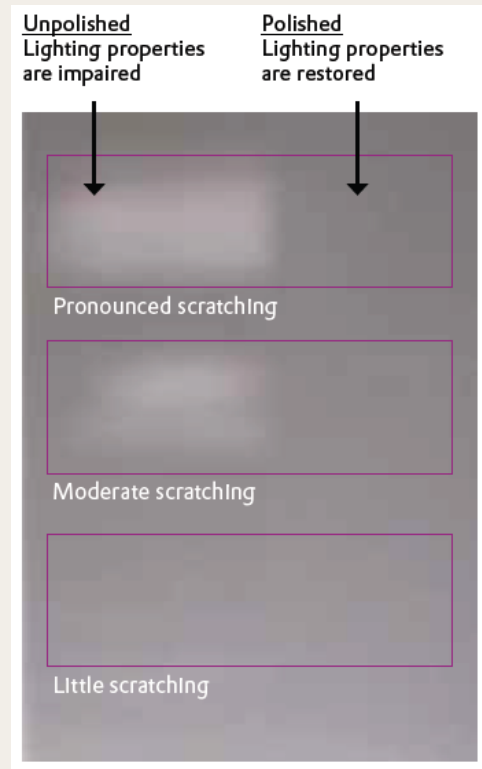

Optimal use of light with ACRYLITE® LED (EndLighten)

Important information at a glance

- To achieve optimal luminous efficiency, the suitable grade of ACRYLITE® LED (EndLighten) (SM to XXL) should be used for the desired area to be illuminated – see page 3.
- Bonding, laminating and printing impair the lighting properties of ACRYLITE® LED (EndLighten) – see page 7.
- All edges should be polished to minimize diffusion losses – see above diagram.
- To avoid light losses via the unlit edges, they should be provided with a reflective surface, e.g. by painting the inside surfaces of the clamping profiles white.
- The LEDs should be placed as close to the edge as possible for optimal light input.

- In transparent applications, it is advisable to use transparent cover sheets to protect against surface scratching – see page 5.
- In non-transparent applications, it is advisable to use a white reflective sheet – see page 6.



FAQs Frequently asked questions

What are the advantages of LED technology?

LEDs are energy-efficient and save electricity. Their service life is over four times longer than that of fluorescent tubes. When their service life is over, all that happens is that their brightness slowly fades. There is no display failure. RGB-LEDs allow various color programs to be run. The light can simply be fed into the edge, and almost all the light passes into the sheet.

What happens if I use the larger grade (XXL) instead of the recommended grade (XL)?

Illumination is still homogeneous. Since the larger grade was optimized for larger surfaces, light will not be as bright as the smaller grade. See page 4.

What happens if I use the smaller grade (L) instead of the recommended grade (XL)?

Illumination is less homogeneous. Since the smaller grade was optimized for smaller surfaces, light no

longer reaches the depths of the sheet. Brightness would decrease in the center. See page 4.

What can be the cause of undesired brightening at the edges? (Corona effect)

It should be ensured that light is only fed into the edge of the ACRYLITE® (EndLighten T) sheet, not into the image carrier, the cover sheet, diffuser sheet or reflective sheet.

What happens if I use ACRYLITE® EndLighten for a transparent application rather than ACRYLITE® LED (EndLighten)?

The application appears duller because of the lacking transparency. Also, ACRYLITE® EndLighten is not as bright when viewed from the front. Homogeneous illumination is still provided.

What happens if I use ACRYLITE® EndLighten instead of ACRYLITE® LED (EndLighten) for a nontransparent application?

Hardly any difference is noticeable. The illumination is still uniform even if ACRYLITE® EndLighten is used, and the brightness will correspond roughly to that of ACRYLITE® LED (EndLighten).

ACRYLITE® LED (EndLighten) has been completely installed, but is not uniformly illuminated when the light is switched on. The masking film is still in place to protect the sheet.

The masking film must be completely removed, and then the light will be properly distributed. The masking film impairs light guiding because of its optical contact with the surface.



This information and all further technical advice is based on our present knowledge and experience. However, it implies no liability or other legal responsibility on our part, including with regard to existing third party intellectual property rights, especially patent rights. In particular, no warranty, whether expressed or implied, or guarantee of product properties in the legal sense is intended or implied. We reserve the right to make any changes according to technical progress or further developments. The customer is not released from the obligation to conduct careful inspection and testing of incoming goods. Performance of the product described herein should be verified by testing, which should be carried out only by qualified experts in the sole responsibility of a customer. Reference to trade names used by other companies is neither a recommendation, nor does it imply that similar products should be used.

Evonik Industries is a worldwide manufacturer of PMMA products sold under the ACRYLITE® trademark in the Americas and under the PLEXIGLAS® trademark in the European, Asian, African, and Australian continents. © Evonik Cyro LLC. All rights reserved.
Printed in the USA.

Evonik Cyro LLC
299 Jefferson Road, Parsippany, NJ 07054 US
Phone +1 800 631 5384
www.acrylite.net www.acrylite-shop.com